

# ETHBrno<sup>2</sup>

November 11 - 13, 2022

Sponsor deck



# What is ETHBrno<sup>2</sup>

## Values

ETHBrno2 is a community initiative, educational event and primarily a hackathon in its purest form. The second edition will be mainly dedicated to the topics around privacy & security. We believe that the right to a privacy is a fundamental human right. And good security fundamentals are an inherent part of it

We are Ethereum people, but we welcome all founders, developers, users and fans of all blockchains and directions who are aware of the urgency of these topics.

Let's learn together to defend against all threats, whether it's loss of privacy, state oppression, smart-contract exploits or simple phishing scams. Let's learn to use the right tools.

And if we don't have them? Let's create them together!

**Don't Trust. Verify. - Run a node - Protect privacy**

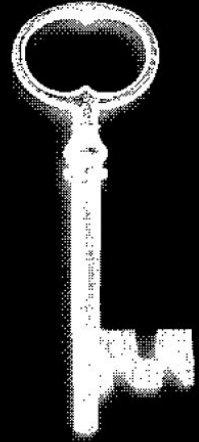

# Hackathon

- Three days of hackathon, collaboration & workshops.
- **300+ hackers**, plus mentors, judges, speakers & staff.
- Educational, creative & cultural experiences aligned including artistic and team building additional activities.
- Community & sponsor collaboration. We encourage all the attendees and supporters to be active. Help us shape the event for the better, whether by hacking, providing on-site mentors or ideas.
- **All blockchains are beautiful.** We welcome you regardless of the ecosystem.

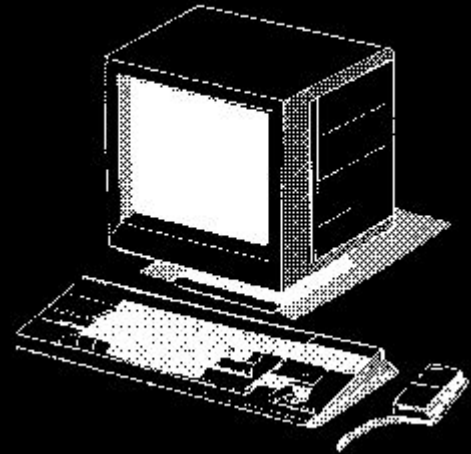

# Why the heck in Brno?

Because Brno is damn cool!

The second largest Czech city after Prague goes by saying “**We’re number two – we try harder**” to the fullest. With a long history of invention and technical thinking, Brno put itself on the map as an origin of **many global companies**, research centres or four different technology incubators.

Brno boasts a total of **10 universities** serving a total of almost 65,000 students, of which one in five is a foreigner.

As it's Central Europe's most central city, it makes getting to and from Brno extremely easy. With numerous bus, train and plane connections, you get to the Europe's other major cities within 3 hours.

Oh, and while there, make sure to check out some of its 1 800+ cultural monuments and UNESCO sites. Or at least one of its World renown [Bar gems](#)

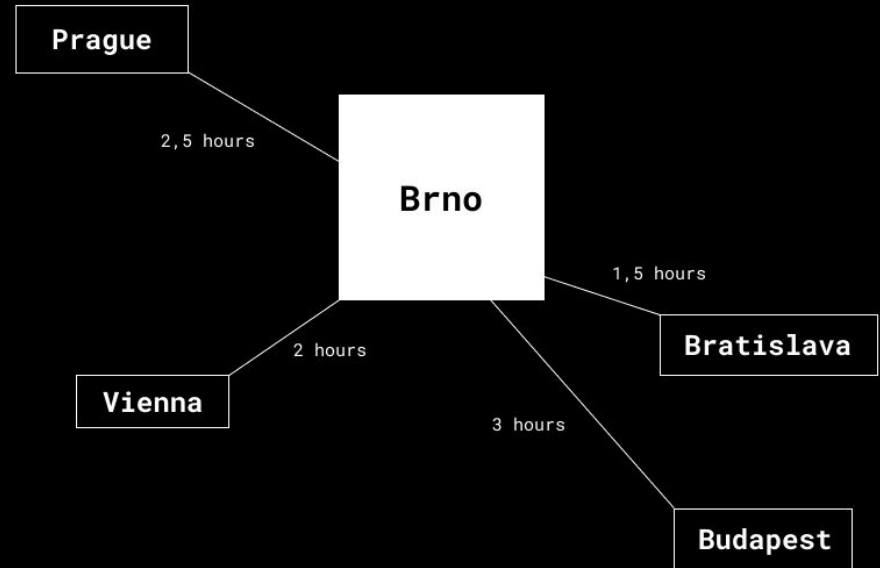

Let's have a look at the  
**sponsorship options**

# Schnorr – only 1

- Recommended 20 000 EUR
- Event opening acknowledgment
- Website logo with backlink
- Social media acknowledgment
- Large featured logo on the main stage, premises and materials
- Large exposed Booth on site by prior arrangement
- Allowance to distribute swag at the venue
- Allowance to organize workshop on-site by prior arrangement
- Hackathon prize handover
- 6 general tickets + 1 judge and 3 mentor tickets (obligation to delegate in advance)

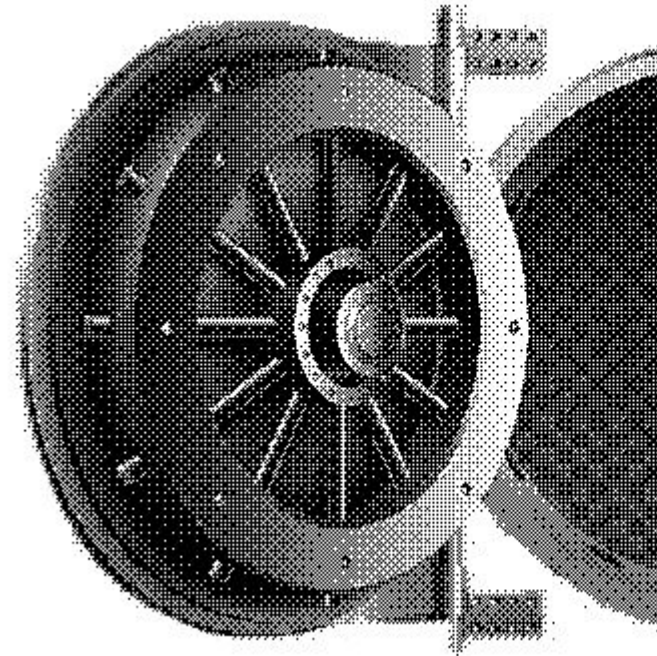

# ECDSA – 3 max

- **Recommended 10 000 EUR**
- Event opening acknowledgment
- Website logo with backlink
- Social media acknowledgment
- Large featured logo on the main stage, premises and materials
- Small booth or desk on site
- Allowance to distribute swag at the venue
- Allowance to organize workshop on-site by prior arrangement
- Hackathon prize handover
- 4 general tickets + 2 mentor tickets (obligation to delegate in advance)

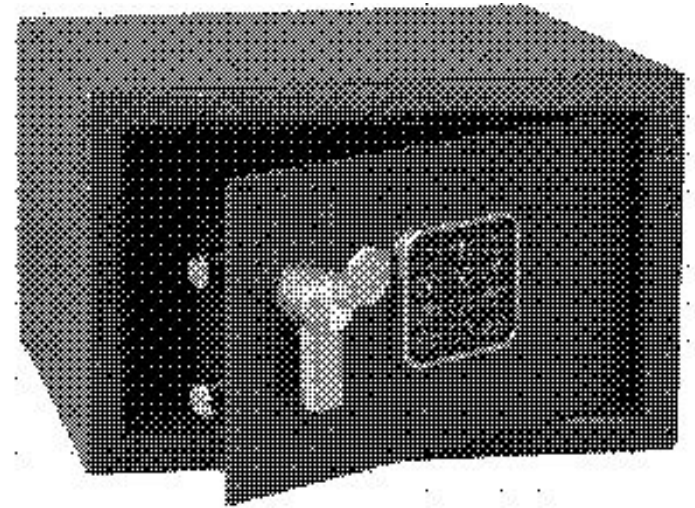

# AES - 3 max

- Recommended 5 000 EUR
- Featured logo on the premises and materials
- Website logo with backlink
- No booth included
- Allowance to distribute swag at the venue
- 3 general tickets + T mentor tickets (obligation to delegate in advance)

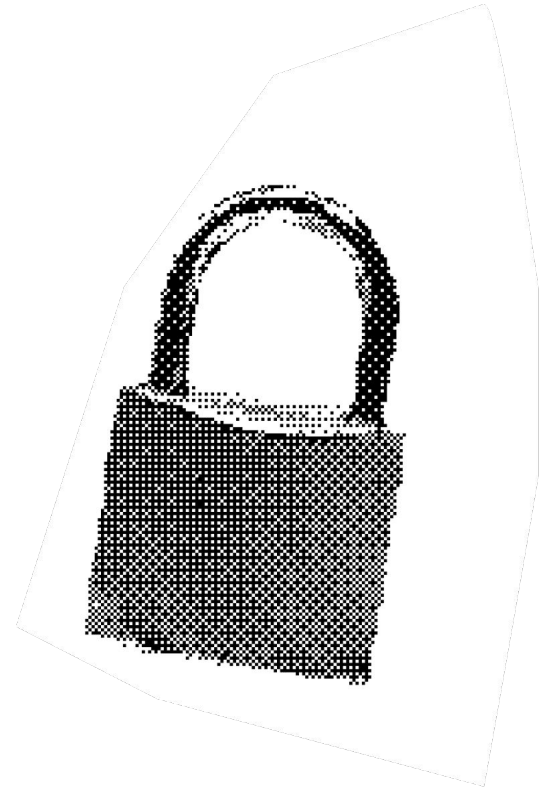



# 3DES - 6 max

- Recommended 2 000 EUR
- Featured logo on the premises and materials
- Website logo with backlink
- No booth included
- Allowance to distribute swag at the venue
- 2 general tickets

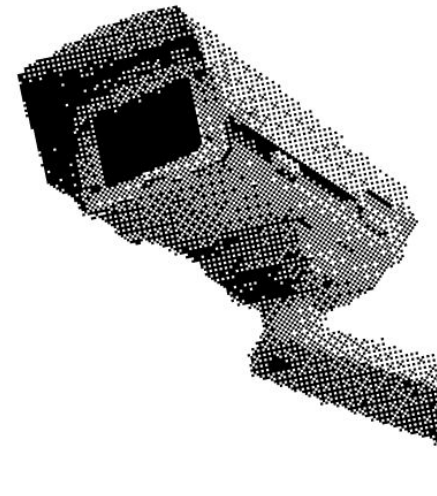

# Community - 10 max

- Recommended 500 EUR
- Featured logo on the premises and materials
- Website logo with backlink
- No booth included
- Allowance to distribute swag at the venue
- 2 general tickets

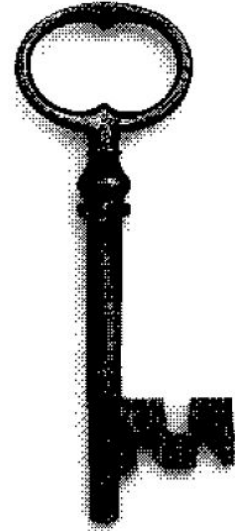

# Sponsorship table

	Schnorr	ECDSA	AES	3DES	Community
Marketing & comms	-Opening acknowledgment -Soc.Media acknowledgment -Logos on the main stage, and premises -Website logo with backlink	-Opening acknowledgment -Soc.Media acknowledgment -Logos on the main stage and premises, -Website logo with backlink	-Logos on-premises on roll-ups, -Website logo with backlink	-Logos on-premises on roll-ups, -Website logo with backlink	-Website logo with backlink
Bounties & Sessions	- 2 000 EUR in bounties - Tech. workshop option	- 1 000 EUR in bounties - Tech. workshop option	- 750 EUR in bounties	- 500 EUR in bounties	- 500 EUR in bounties
Booths & swag	-Large exposed booth -swag bag insert	-Small booth or desk -swag bag insert	allowance to distribute swag	allowance to distribute swag	allowance to distribute swag
Tickets	6 general 1 judge 3 mentors (10 in total)	4 general 2 mentors (6 in total)	3 general 1 mentors (4 in total)	2 general (2 in total)	2 general (2 in total)
Amount	20 000 EUR	10 000 EUR	5 000 EUR	2 000 EUR	500 EUR
Available	1	3	3	6	10

# Who are we?

We are UTXO Foundation, a non-profit association dedicated to education in the field of blockchain and cryptocurrencies. Uniting several Czech crypto communities such as Czech Ethereum and DeFi community [Gwei.cz](https://www.gwei.cz) with a local branch of a [Bankless Czech](#), [BohemianDAO](#), and [Women in crypto](#) organization supporting beginners and slightly advanced users.

Among regular offline and online meetups and workshops, last year we organized ETHBrno conference (10/9) for more than 200 people. This year we took it a step further and organized the largest open crypto conference in the Czech Republic and Slovakia [UTXO.22](#) (9/4-5). With more than 1 300 visitors and 126 speakers on site, including local influential people, politicians and the top of the crypto industry, it introduced and educated both the general public as well as advanced users about open blockchains and their principles such as decentralization, neutrality, openness, trustlessness, cooperation, and related topics.

**Our goal is to support and also connect individual communities with each other.** In order to do so, we help and support multiple communities in the organization of specialized conferences, while providing a space for them to connect. Both locally and internationally.

# Place

The ETHBrno2 **hackathon** will take place in **Impact HUB space** in Brno. Within a 10-minute walk from the city center and the main train station, it provides all the necessary facilities for a hackathon at this level.

Impact HUB will serve as the main venue, probably supplemented by another place within a 3-minute walk distance, to expand both the content and, above all, the convenience. Content in these will be running simultaneously.



# Hackathon advisors

The patronage of our hackathon was taken over by world-renowned individuals and creators coming from the local scene.



**Mario Havel**

Ethereum Foundation,  
Bordel Hackerspace



**Josef J**

ETHPrague, PWN Finance  
(previously EF & Devcon)



**Anett Rolikova**

Nethermind, previously  
Ethereum Magicians



**dcbuilder.eth**

Worldcoin,  
devpill.me (👤, 💊)

E-mail: [ethbrno@utxo.foundation](mailto:ethbrno@utxo.foundation)

Twitter: [@ethbrno](https://twitter.com/ethbrno)

Discord: [ETHBrno<sup>2</sup>](https://discord.com/invite/ETHBrno2)

[/join #ethbrno:matrix.org](https://matrix.org/join/ethbrno:matrix.org)

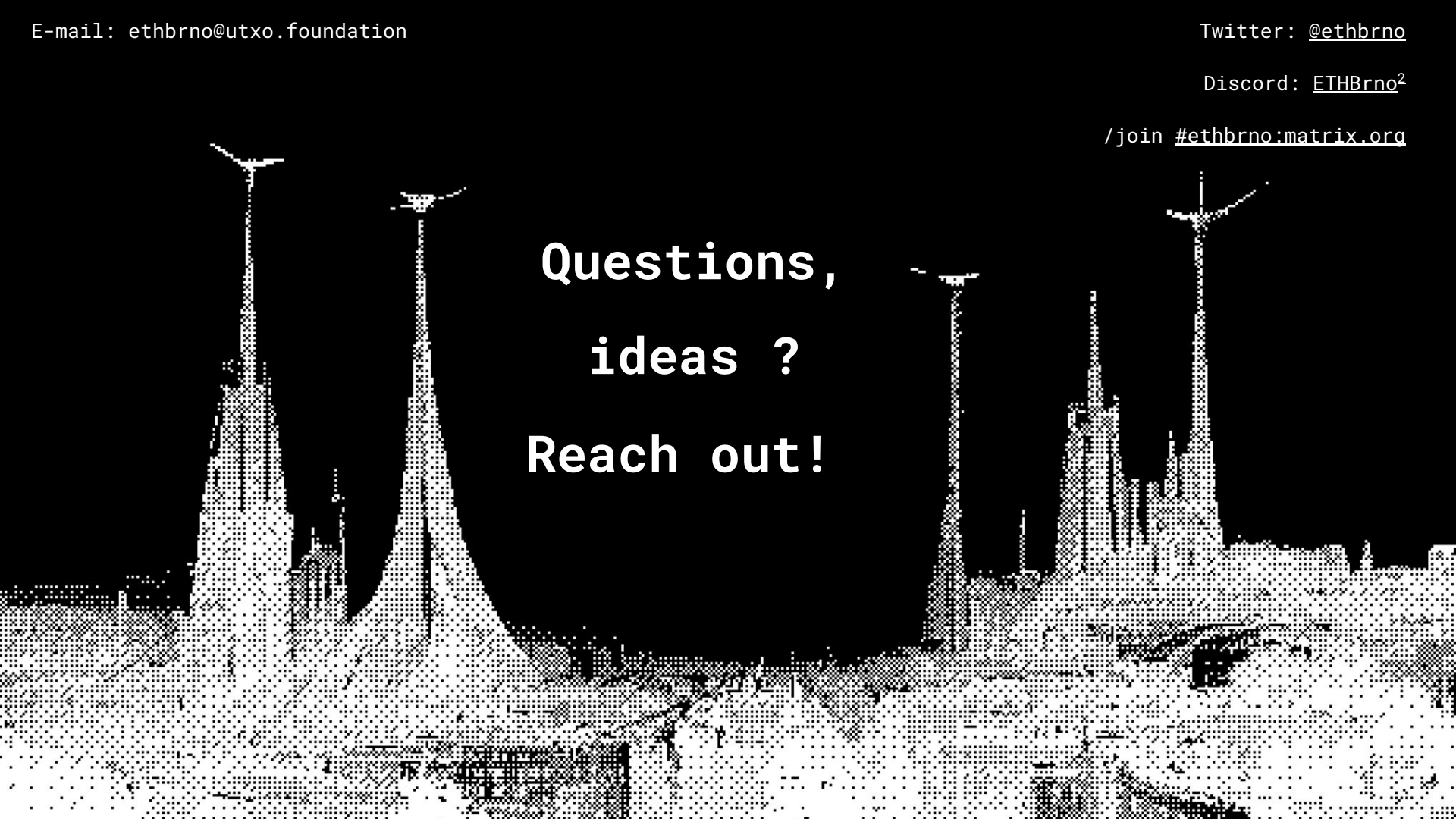

**Questions,  
ideas ?  
Reach out!**